



P-channel -60V, -30A, TO-220 Trench Power MOSFET 溝槽式功率場效應管

■Features 特點

Advanced trench technology 优秀沟槽技术

Ultra low on-resistance 超低導通電阻

Low gate charge 低栅電荷密度

Fast switching 快速開關能力

■Applications 應用

Switch mode power supplies 開關電源

DC-DC converters and UPS 直流直流变换和不间断電源

PWM motor controls 脉宽调制電機控制

General switching applications 普通開關應用

■Internal Schematic Diagram 内部結構

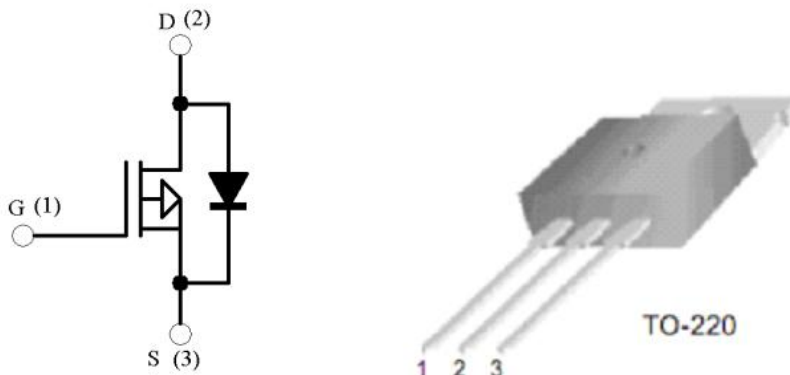

■Absolute Maximum Ratings 最大額定值

Characteristic 特性參數	Symbol 符號	Rat 額定值	Unit 單位
Drain-Source Voltage 漏極-源極電壓	BV_{DSS}	-60	V
Gate- Source Voltage 栅極-源極電壓	V_{GS}	± 20	V
Drain Current (continuous)漏極電流-連續	I_D (at $TC = 25^\circ C$)	-30	A
Drain Current (pulsed)漏極電流-脉冲	I_{DM}	-140	A
Total Device Dissipation 總耗散功率	P_{TOT} (at $TC = 25^\circ C$ at $TC = 100^\circ C$)	31 15	W
Thermal Resistance Junction-Ambient 熱阻	$R_{\theta JA}$	65	$^\circ C/W$
Junction/Storage Temperature 結溫/儲存溫度	T_J, T_{stg}	-55~150	$^\circ C$



■ Electrical Characteristics 電特性

($T_A=25^{\circ}\text{C}$ unless otherwise noted 如無特殊說明，溫度為 25°C)

Characteristic 特性參數	Symbol 符號	Min 最小值	Typ 典型值	Max 最大值	Unit 單位
Drain-Source Breakdown Voltage 漏極-源極擊穿電壓($I_D=-250\mu\text{A}, V_{GS}=0\text{V}$)	BV_{DSS}	-60	—	—	V
Gate Threshold Voltage 柵極開啓電壓($I_D=-250\mu\text{A}, V_{GS}=V_{DS}$)	$V_{GS(th)}$	-1	-1.6	-2.5	V
Zero Gate Voltage Drain Current 零柵壓漏極電流($V_{GS}=0\text{V}, V_{DS}=-48\text{V}$)	I_{DSS}	—	—	-1	μA
Gate Body Leakage 柵極漏電流($V_{GS}=\pm 20\text{V}, V_{DS}=0\text{V}$)	I_{GSS}	—	—	± 100	nA
Static Drain-Source On-State Resistance 靜態漏源導通電阻($I_D=-10\text{A}, V_{GS}=-10\text{V}$) ($I_D=-5\text{A}, V_{GS}=-4.5\text{V}$)	$R_{DS(ON)}$	—	60 85	66 95	$\text{m}\Omega$
Source Drain Current 源極-漏極電流	I_{SD}	—	—	-2.4	A
Diode Forward Voltage Drop 內附二極管正向壓降($I_{SD}=-1.7\text{A}, V_{GS}=0\text{V}$)	V_{SD}	—	—	-1.2	V
Input Capacitance 輸入電容 ($V_{GS}=0\text{V}, V_{DS}=-15\text{V}, f=1\text{MHz}$)	C_{ISS}	—	665	—	pF
Common Source Output Capacitance 共源輸出電容($V_{GS}=0\text{V}, V_{DS}=-15\text{V}, f=1\text{MHz}$)	C_{OSS}	—	137	—	pF
Total Gate Charge 柵極電荷密度 ($V_{DS}=-15\text{V}, I_D=-8\text{A}, V_{GS}=-10\text{V}$)	Q_g	—	9	—	nC
Gate Source Charge 柵源電荷密度 ($V_{DS}=-15\text{V}, I_D=-8\text{A}, V_{GS}=-10\text{V}$)	Q_{gs}	—	3.7	—	nC
Gate Drain Charge 柵漏電荷密度 ($V_{DS}=-15\text{V}, I_D=-8\text{A}, V_{GS}=-10\text{V}$)	Q_{gd}	—	3	—	nC
Turn-On Delay Time 開啓延遲時間 ($V_{DS}=-15\text{V}, I_D=-1\text{A}, R_{GEN}=6\Omega, V_{GS}=-10\text{V}$)	$t_{d(on)}$	—	11	—	ns
Turn-On Rise Time 開啓上升時間 ($V_{DS}=-15\text{V}, I_D=-1\text{A}, R_{GEN}=6\Omega, V_{GS}=-10\text{V}$)	t_r	—	5	—	ns
Turn-Off Delay Time 關斷延遲時間 ($V_{DS}=-15\text{V}, I_D=-1\text{A}, R_{GEN}=6\Omega, V_{GS}=-10\text{V}$)	$t_{d(off)}$	—	30	—	ns
Turn-On Fall Time 開啓下降時間 ($V_{DS}=-15\text{V}, I_D=-1\text{A}, R_{GEN}=6\Omega, V_{GS}=-10\text{V}$)	t_f	—	7	—	ns

■ TYPICAL CHARACTERISTIC CURVE 典型特性曲线

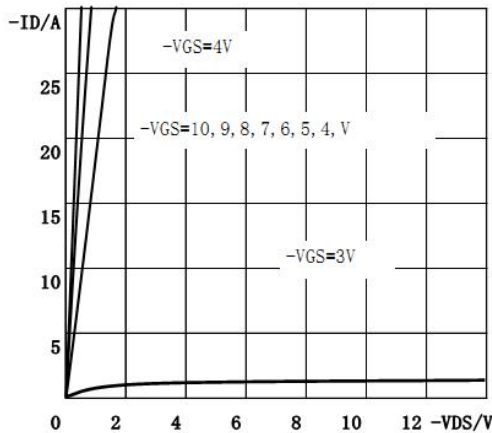

Figure 1. Output Characteristics

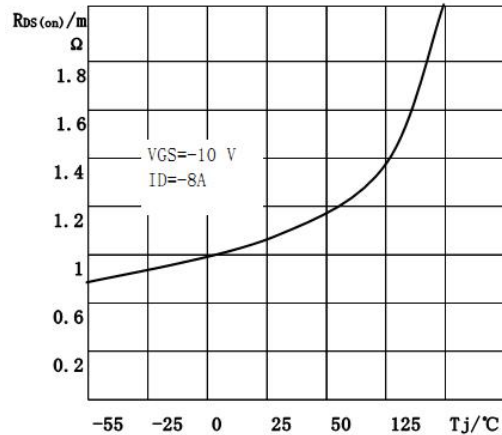

Figure 2. On-Resistance Variation with Temperature

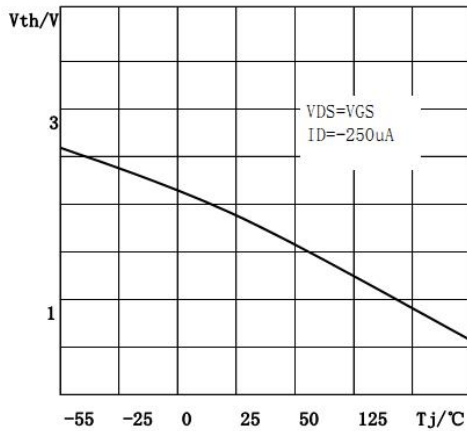

Figure 3. Gate Threshold Variation with Temperatures

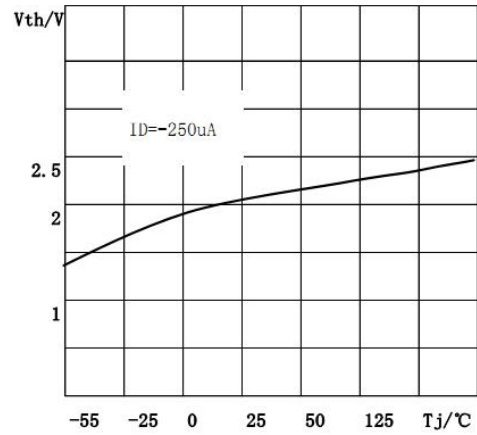

Figure 4. Breakdown Voltage Variation with temperatures

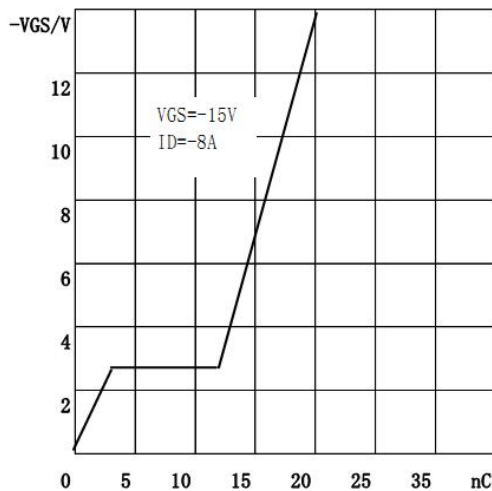

Figure 5. Gate charge VS. Gate-source Voltage

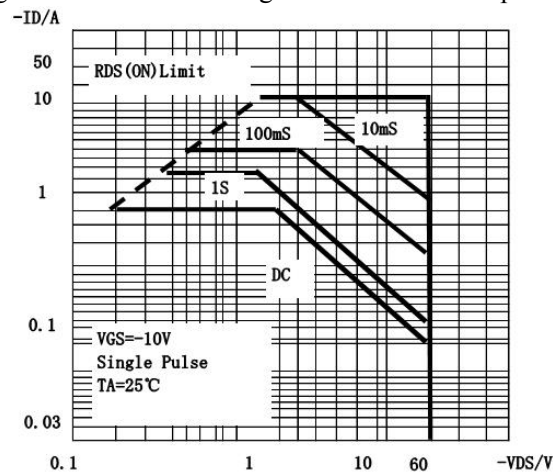
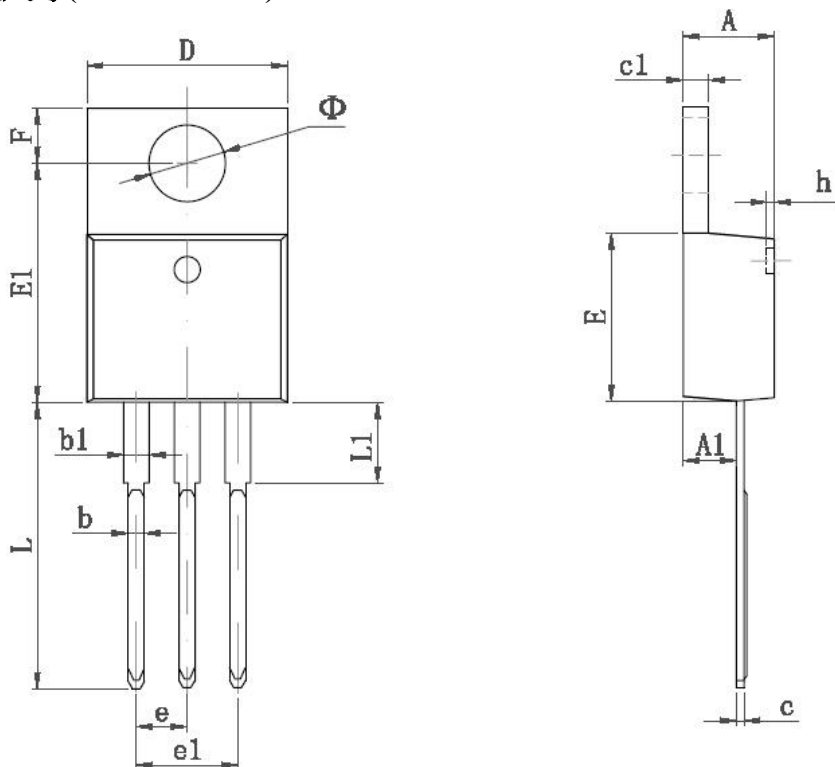

Figure 6. Maximum Safe Operating Area



TO-220 外形封裝尺寸(DIMENSION)



Symbol	Dimensions In Millimeters		Dimensions In Inches	
	Min	Max	Min	Max
A	4.470	4.670	0.176	0.184
A1	2.520	2.820	0.099	0.111
b	0.710	0.910	0.028	0.036
b1	1.170	1.370	0.046	0.054
c	0.310	0.530	0.012	0.021
c1	1.170	1.370	0.046	0.054
D	10.010	10.310	0.394	0.406
E	8.500	8.900	0.335	0.350
E1	12.060	12.460	0.475	0.491
e	2.540TYPE		0.100TYPE	
e1	4.980	5.180	0.196	0.204
F	2.590	2.890	0.102	0.114
h	0.000	0.300	0.000	0.012
L	13.400	13.800	0.528	0.543
L1	3.560	3.960	0.140	0.156
Φ	3.735	3.935	0.147	0.155